



We Make The Difference



ERC

CE



II 2 G h IIB T4 Gb
II 2 D h IIB 135 °C Db
Bassefa15ATEX13DR/RN3

5 YEARS
LIMITED
WARRANTY



Ruby Air Operated Diaphragm Pumps

www.alphadynamic.eu

Ruby Air Operated Diaphragm pumps



New pump line with a brand new designing that offers reinforced pumping potentials. The updated designing provides the possibility to use also other materials at the hydraulic parts without decreasing the efficiency in pressure. Plus, it offers even bigger performance provided with economy

Ruby Pumps composition codes

Model	Pump Body	Center Section	Diaphragms	Ball Seats	Valve Ball	O-ring	Other Options
MINI 005 MINI 017 Ruby 010 Ruby 012 Ruby 015 Ruby 115 Ruby 020 Ruby 120 Ruby 025 Ruby 125 Ruby 040 Ruby 140 Ruby 050 Ruby 150 Ruby 051 Ruby 080 Ruby 081	P: PP V: PVDF+CF A: Aluminum S: Stainless Steel 316 PC: PP+CF	P: PP A: Aluminum PC: PP+CF W: PP FDA	N: NBR Conductive E: EPDM Conductive F: VITON Conductive T: PTFE+back up (EPDM Conductive) Z: PTFE A+back up (EPDM Conductive) ST: PTFE+back up (SANTOPRENE) HY: PTFE+ back up (HYTREL) NT: PTFE+Back up (NBR)	V: PVDF S: AISI 316 T: PTFE A: Aluminum P: PP N: NBR E: EPDM O: POM-C	T: PTFE S: AISI 316 N: NBR E: EPDM	T: PTFE F: VITON E: EPDM N: NBR	F: Flange PN10/ANSI150 D: Twin Manifold

Main features

Available in PP, PP+CF, PVDF+CF, ALUMINUM and STAINLESS STEEL 316

- Use in potentially explosive atmospheres (conductive series)



II 2 G h IIB T4 Gb
II 2 D h IIB 135° C Db
Bassefa15ATEX13DR/RN3

- Optimal performance
- Economical air consumption, ecological designing
- High efficiency for pressure/capacity
- Oil free operation
- No freezing
- New air valve designing, fully controlled air passing
- Easy disassembling and re-assembling
- New generation diaphragms with embodied inner-outer piston
- New generation PTFE diaphragms of embodied type for long-life operation (compound)
- Advanced quality Full capacity PTFE-A diaphragms for high chemical and mechanical applications
- Potential to be submersible (on request)
- Possibility to be used in dirty environments due to their closed designing
- Easy manifold reverse
- Automatic suction
- Twin manifold option (two suction and two delivery)
- Excellent performance and value for money
- Ideal for abrasive, viscous, and shear sensitive media

How it works

The Ruby diaphragm pump is an air-operated, positive displacement, self-priming pump. These drawings show flow pattern through the pump upon it's initial stroke. It is assumed the pump has no fluid in it, prior to it's initial stroke

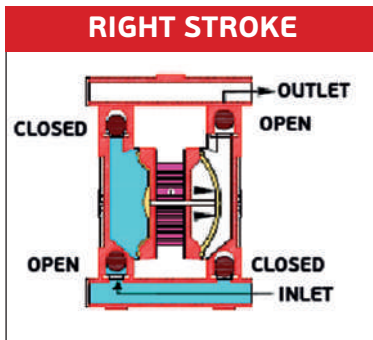

FIGURE 1 The air valve directs pressurized air to the back side of diaphragm A. The compressed air is applied directly to the liquid column separated by elastomeric diaphragms. The diaphragm acts as a separation membrane between the compressed air and liquid, balancing the load and removing mechanical stress from the diaphragm. The compressed air moves the diaphragm away from the center block of the pump. The opposite diaphragm is pulled in by the shaft connected to the pressurized diaphragm. Diaphragm B is on it's suction stroke; air behind the diaphragm has been forced out to the atmosphere through the exhaust port of the pump. The movement of diaphragm B toward the center block of the pump creates a vacuum within chamber B. Atmospheric pressure forces fluid into the inlet manifold forcing the inlet valve ball off its seat. Liquid is free to move past the inlet valve ball and fill the liquid chamber (see shaded area).

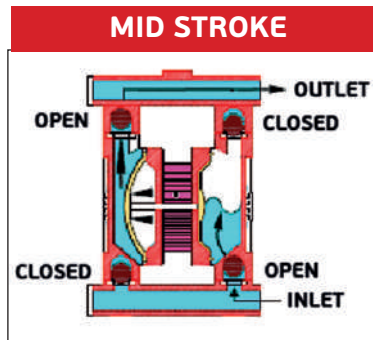

FIGURE 2 When the pressurized diaphragm, diaphragm A, reaches the limit of it's discharge stroke, the air valve redirects pressurized air to the back side of diaphragm B. The pressurized air forces diaphragm B away from the center block while pulling diaphragm A to the center block. Diaphragm B is now on its discharge stroke. Diaphragm B forces the inlet valve ball onto its seat due to the hydraulic forces developed in the liquid chamber and manifold of the pump. These same hydraulic forces lift the discharge valve ball off it's seat, while the opposite discharge valve ball is forced onto it's seat, forcing fluid to flow through the pump discharge. The movement of diaphragm A toward the center block of the pump creates a vacuum within liquid chamber B. Atmospheric pressure forces fluid into the inlet manifold of the pump. The inlet valve ball is forced off it's seat allowing the fluid being pumped to fill the liquid chamber.

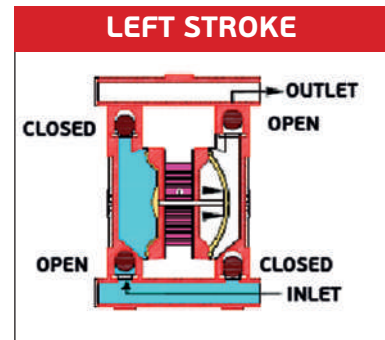
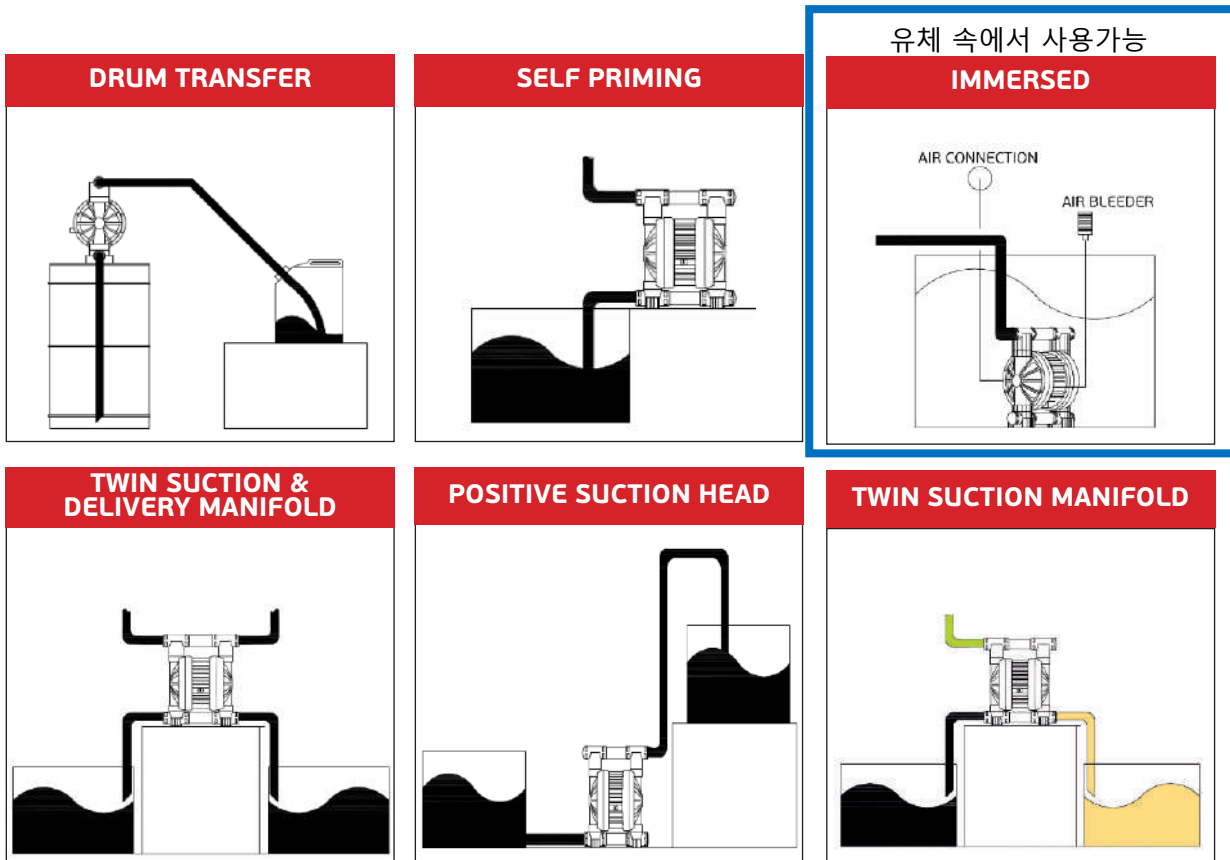

FIGURE 3 At completion of the stroke, the air valve again redirects air to the back side of diaphragm A, which starts diaphragm B on its exhaust stroke. As the pump reaches it's original starting point, each diaphragm has gone through one exhaust and one discharge stroke. This constitutes one complete pumping cycle. The pump may take several cycles to completely prime depending on the conditions of the application.

Installation



ATEX Certificate



AlphaDynamic PUMPS has stored the documentation certifying ATEX compliance according to Directive 2014/34/EC for its ranges of Ruby air operated diaphragm pumps with the SGS Baseefa Limited certification body.

They are manufactured in a CONDUCT class II 2G h IIB T4 Gb and II 2D h IIB 135°C Db.

The equipment user is responsible for classifying its area

On the other hand, the manufacturer shall identify and affix the certification class of the manufactured equipment.

Advance Unified Diaphragms Featuring

- ✓ Easy installation and maintenance
- ✓ Excellent service life
- ✓ Inventory cost reduction
- ✓ Improved performance
- ✓ Greater displacement per cycle
- ✓ No center hole, elimination of potential leak paths.
- ✓ There is no need for the main axis to be insured
- ✓ They can be screwed and unscrewed without the use of tools



Advance Unified Diaphragm Offers:

The prominences decrease the stretching of the PTFE during the regression and prevent it from cracking.

Exclusive conical shape provides excellent service life, suction lift and lower start-up pressure

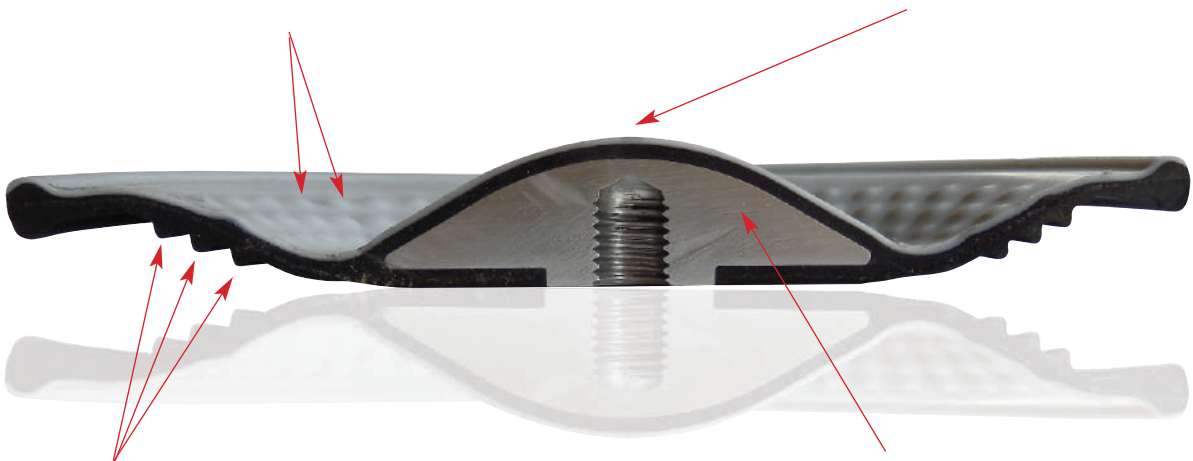

Backing ribs sustain and guide the diaphragm's flexibility for extended life and reduced cavitation on suction stroke

Oversized integrated plate supports nearly 50% of the diaphragm through the entire dynamic motion.

Minipump 005

Construction materials: PP – PP+CF



Minipump 005

Minipump 017

Construction materials: PP, PP+CF, ECTFE



Minipump 017



Technical data

	Minipump 005	Minipump 017
ATEX certification	Ex II 2 G h IIB T4 Gb and II 2 D h IIIB 135°C Db	
Construction materials	PP, PP+CF	PP, ECTFE, PP+CF
Intake/delivery connections	G 1/4"	G 3/8"
Air connection	1/8"	3/8"
Max. self-priming capacity	3 m	3 m
Max. flow rate	5 l/min	17 l/min
Max. head	70 m	70 m
Max. air supply pressure	7 bar	7 bar
Diameter	0,5 mm	0,5 mm
Max. operating temp.	60°C	PP, PP+CF: 60°C, ECTFE: 90°C
Weight	0,5Kg	1Kg, ECTFE 1,5Kg

* The curves and performance values refer to pumps with submerged suction and a free delivery outlet with water at 20°C, and vary according to the construction material.

Performance Minipump 005

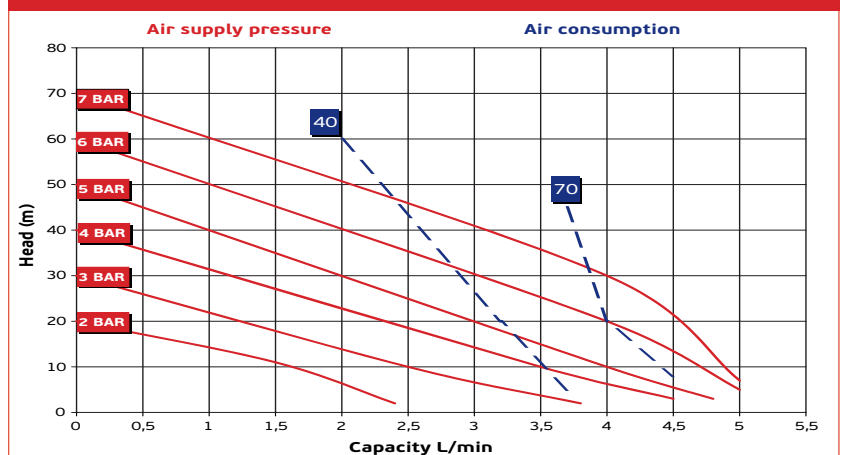

Performance Minipump 017

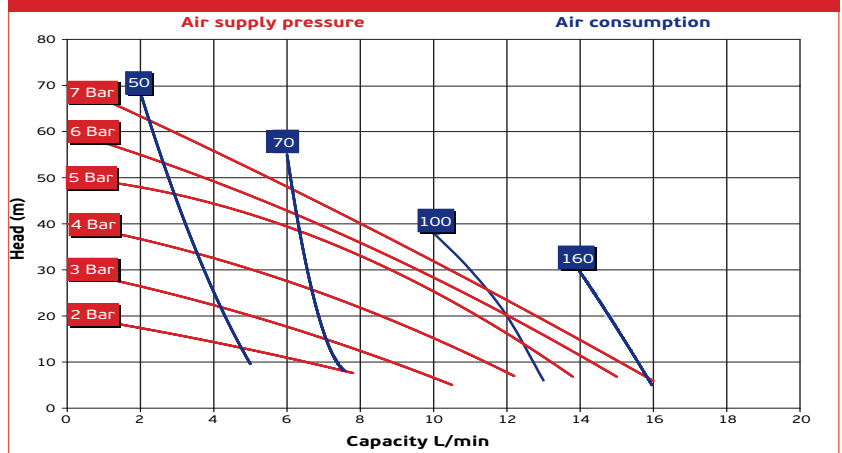

Ruby 010

Construction materials: PP - PVDF- PP+CF -AISI 316

Technical data

ATEX certification	⊕ II 2 G h IIB T4 Gb and II 2 D h IIB 135°C Db
Construction Materials	PP, PP+CF, PVDF+CF, AISI 316
Diaphragms	NT: TFM+Back up(NBR)
Intake/Delivery connections	3/8 "
Air Connection	3/8 "
*Max.self-priming capacity	4 m
*Max. Flow rate	21 L/min
Max. Head	70 m
Max. Air supply pressure	7 Bar
Max. Solids	0.5 mm
Max. Temperature	PP, PP+CF: 60 °C, PVDF: 95 °C, AISI316: 95 °C
Weight PP, PP+CF	1.2 Kg
Weight PVDF	1.9 Kg
Weight AISI 316	3.0 Kg

* The curves and performance values refer to pumps with submerged suction and a free delivery outlet with water at 20°C, and vary according to the construction material.

CURVES RUBY 010

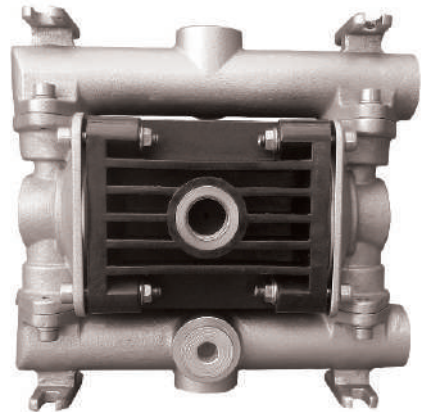
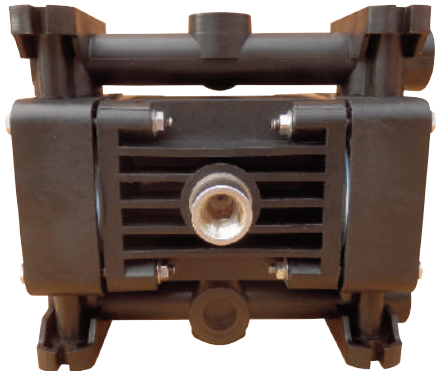
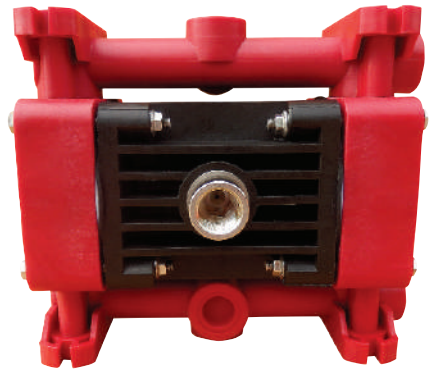
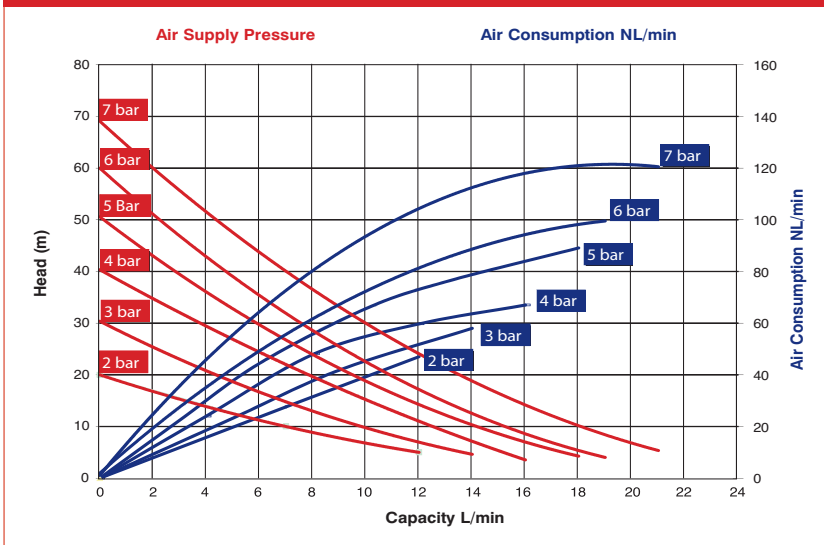

Ruby 012 Pump

Construction materials: PP - PVDF- PP+CF



Technical data

ATEX certification	II 2 G h IIB T4 Gb and II 2 D h IIIB 135°C Db
Construction materials	PP, PVDF+CF, PP+CF
Diaphragms	PTFE+back up (Santoprene)
	PTFE+back up (EPDM)
	SANTOPRENE HYTREL
Intake/delivery connections	G 1/2"
Air connection	1/4"
Max. self-priming capacity	4 m
Max. flow rate	30 L/min
Max. head	70 m
Max. air supply pressure	7 bar
Max solid size (diameter)	2 mm
Max. operating temp.	PP, PP+CF: 60°C, PVDF: 95°C
Weight PP , PP+CF	1,6 Kg
Weight PVDF	1,9 Kg

* The curves and performance values refer to pumps with submerged suction and a free delivery outlet with water at 20°C, and vary according to the construction material.

CURVES RUBY 012

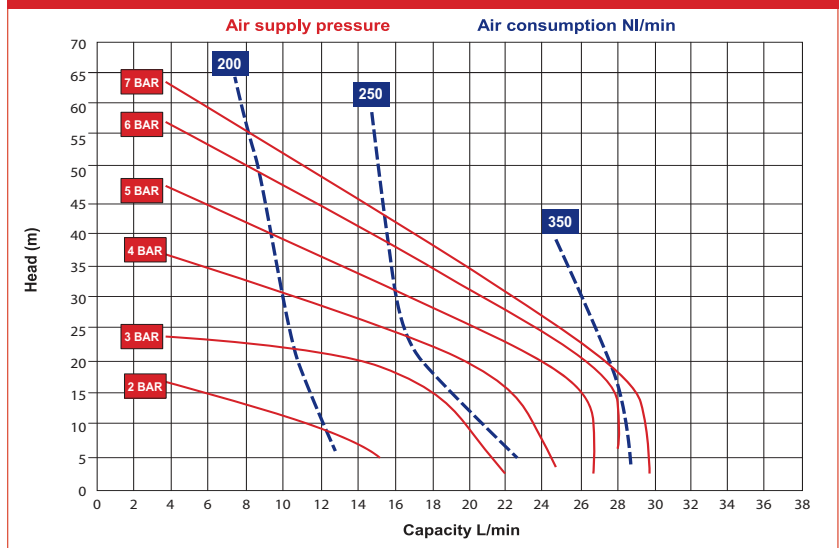

Ruby 015 Pump

Construction materials: **AISI 316**

Technical data

ATEX certification	Ex II 2 G h IIB T4 Gb and II 2 D h IIB 135°C Db
Construction materials	AISI 316
Diaphragms	NBR Conductive EPDM Conductive Compound PTFE+Back up EPDM Conductive Compound PTFE A + Back up EPDM Conductive VITON Conductive
Intake/delivery connections	1/2" BSP G-Flange on Request
Air connection	1/2"
*Max. self-priming capacity	4 m
*Max. flow rate	72 L/min
Max. head	70 m
Max. air supply pressure	7 bar
Diameter	3,0 mm
Max. operating temp.	95 °C
Weight AISI 316	9,0 kg



* The curves and performance values refer to pumps with submerged suction and a free delivery outlet with water at 20°C, and vary according to the construction material.

CURVES RUBY 015 PTFE FULL CAPACITY FITTED

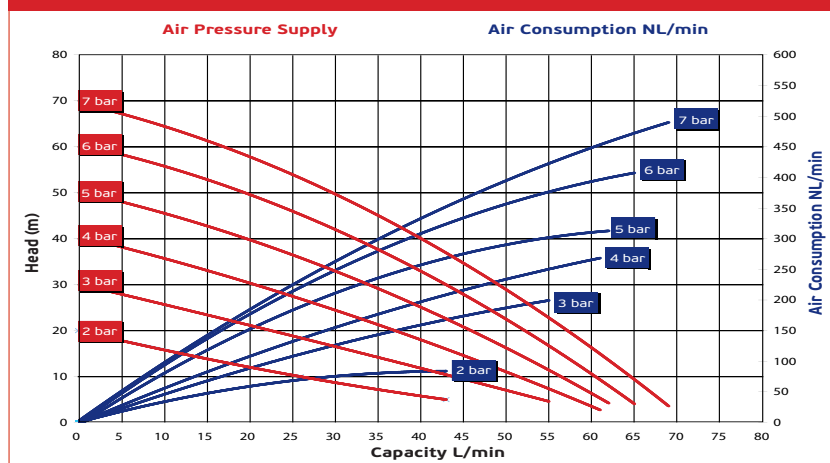

CURVES RUBY 015 RUBBER FITTED

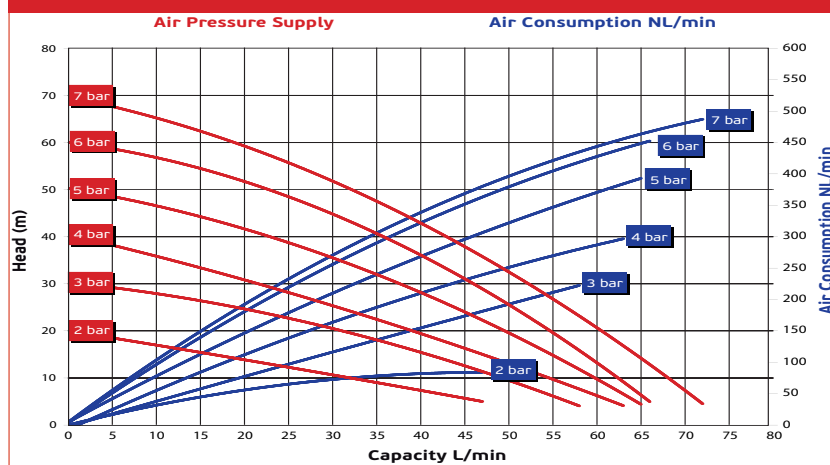

Ruby 115

Construction materials: PP - PVDF+CF - ALUMINIUM - PP+CF

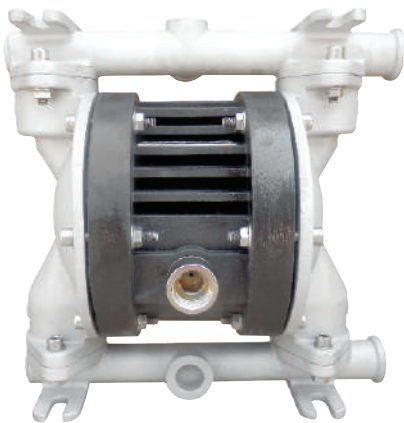
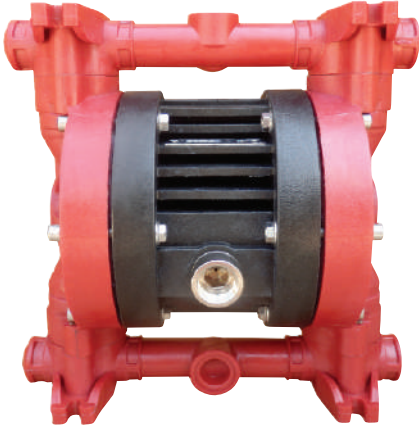

Technical data

ATEX certification	Ⓔ II 2 G h IIB T4 Gb and II 2 D h IIB 135°C Db
Construction materials	PP, PVDF+CF, ALUMINIUM, PP+CF
Diaphragms	NBR Conductive EPDM Conductive Compound PTFE+Back up EPDM Conductive Compound PTFE A + Back up EPDM Conductive VITON Conductive
Intake/delivery connections (standard)	G 1/2" BSP G – Flange on request
Air connection	1/2"
*Max. Self-priming capacity	3 m
*Max. flow rate	74 L/min
Max. head	80 m
Max. air supply pressure	8 bar
Max. solid size (diameter)	3,0 mm
Max. operating temperature	PP 60°C, PVDF+CF 95°C, Aluminium 95°C, PP+CF 60°C
Weight PP	4,0 kg
Weight PVDF	5,5 Kg
Weight Aluminium	6,0 kg

* The curves and performance values refer to pumps with submerged suction and a free delivery outlet with water at 20°C, and vary according to the construction material.

RUBY 115 - FULL CAPACITY PTFE - A FITTED

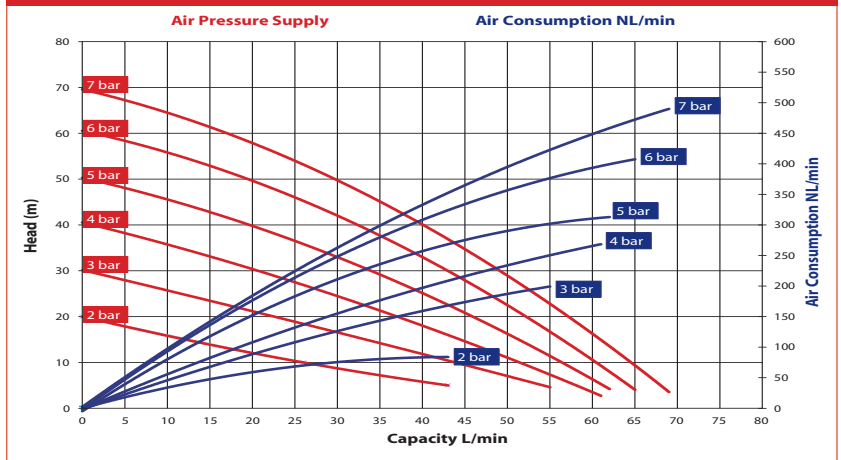

RUBY 115 - RUBBER FITTED

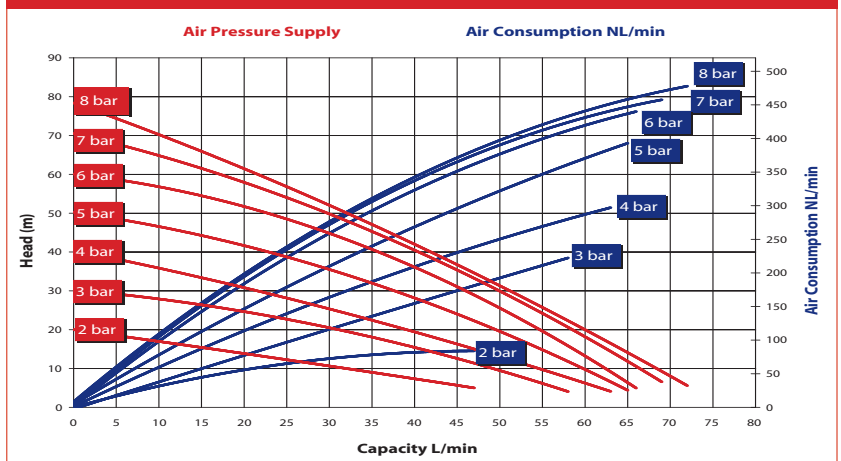

Ruby 020 Pump

Construction materials: PP – PVDF - PP+CF

Technical data

ATEX certification	⊕ II 2 G h IIB T4 Gb and II 2 D h IIB 135°C Db
Construction materials	PP, PVDF, PP+CF
Diaphragms	NBR Conductive EPDM Conductive Compound PTFE+Back up EPDM Conductive Compound PTFE A + Back up EPDM Conductive VITON Conductive
Intake/delivery connections	3/4" BSP G -Flange on Request
Air connection	1/2"
*Max. self-priming capacity	4 m
*Max. flow rate	117 L/min
Max. head	80 m
Max. air supply pressure	8 bar
Diameter	3,0 mm
Max. operating temp.	PP 60°C, PVDF 95°C
Weight PP	4,0 kg
Weight PVDF	5,5 Kg

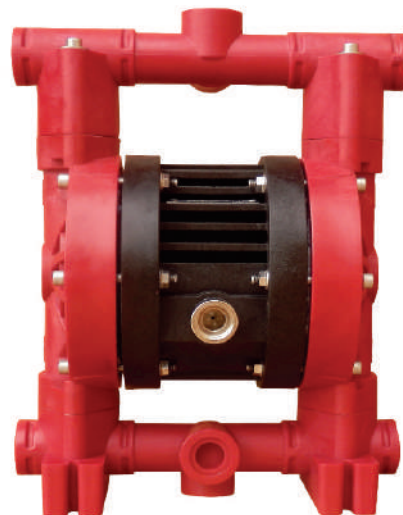

* The curves and performance values refer to pumps with submerged suction and a free delivery outlet with water at 20°C, and vary according to the construction material.

RUBY 020 - FULL CAPACITY PTFE - A FITTED

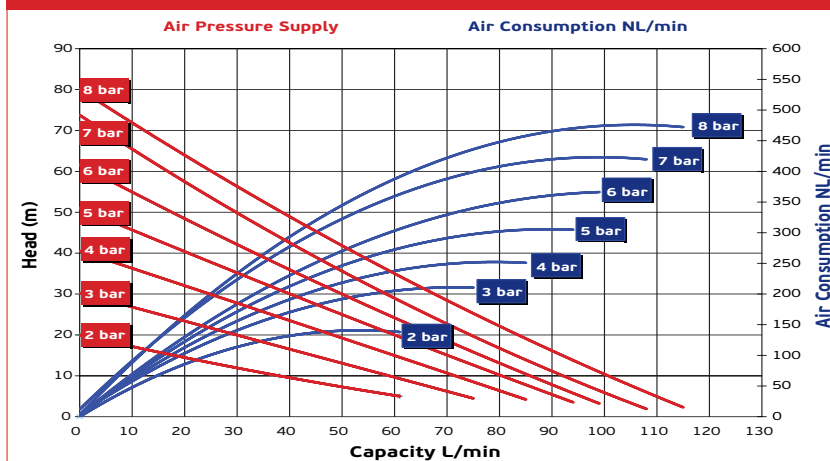

RUBY 020 - RUBBER FITTED

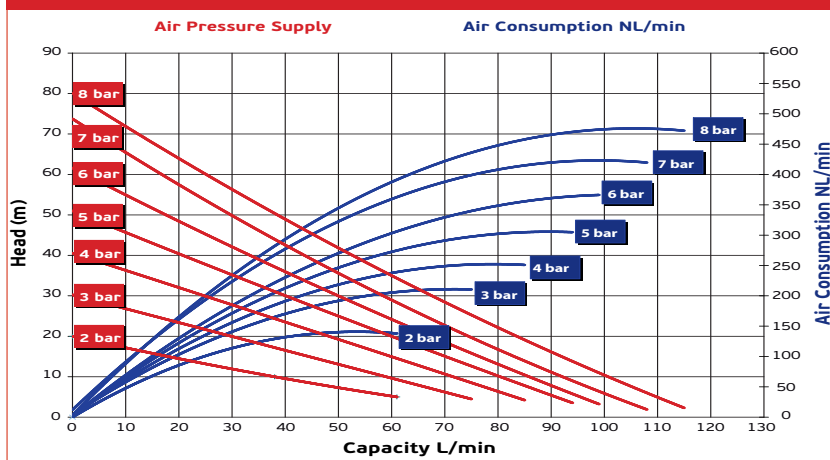

Ruby 120

Construction materials: **ALUMINIUM**



Technical data

ATEX certification	⊕ II 2 G h IIB T4 Gb and II 2 D h IIB 135°C Db
Construction materials	Aluminum
Diaphragms	NBR Conductive EPDM Conductive Compound PTFE+Back up EPDM Conductive Compound PTFE A + Back up EPDM Conductive VITON Conductive
Intake/delivery connections	3/4" BSP G -Flange on Request
Air connection	1/2"
*Max. self-priming capacity	4 m
*Max. flow rate	117 L/min
Max. head	80 m
Max. air supply pressure	8 bar
Diameter	3,0 mm
Max. operating temp.	95°C
Weight	6,0 kg

* The curves and performance values refer to pumps with submerged suction and a free delivery outlet with water at 20°C, and vary according to the construction material.

RUBY 120 - FULL CAPACITY PTFE - A FITTED

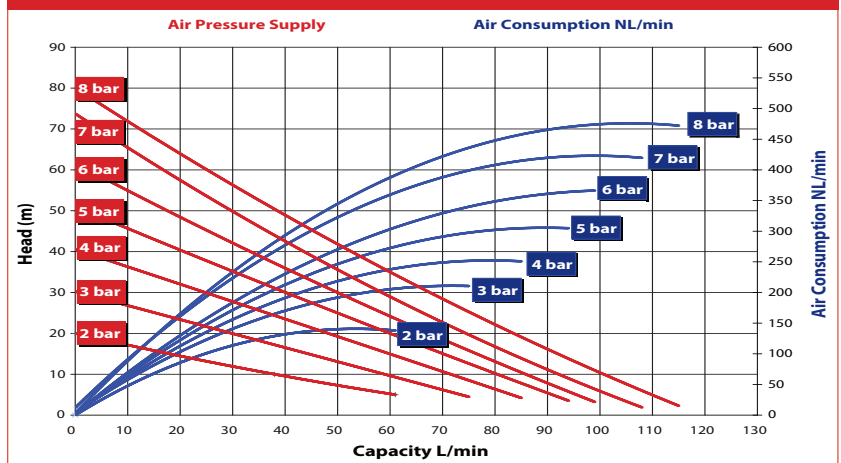

RUBY120 - RUBBER FITTED

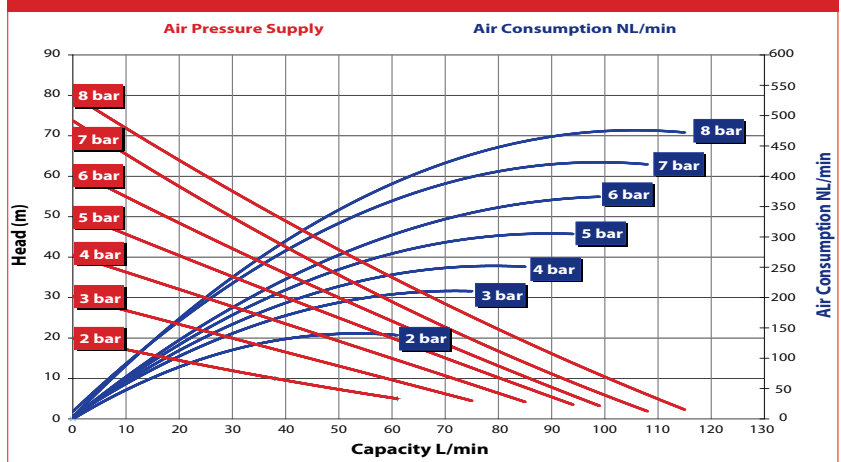

Ruby 025 Pump

Construction materials: PP – PP+CF – PVDF+CF – AISI316

Technical data

ATEX certification	⊕ II 2 G h IIB T4 Gb and II 2 D h IIB 135°C Db
Construction materials	PP, PP+CF, PVDF+CF, AISI316
Diaphragms	NBR Conductive EPDM Conductive Compound PTFE+Back up EPDM Conductive Compound PTFE A+Back up EPDM Conductive VITON Conductive
Intake/delivery connections	1" BSP G -Flange on Request
Air connection	1/2"
*Max. self-priming capacity	4 m
*Max. flow rate	175 l/min
Max. head	70 m
Max. air supply pressure	7 bar
Diameter	3,5 mm
Max. operating temp.	PP 60°C, PVDF 95°C, AISI 316 95°C, 130°C with Metallic center block
Weight PP	6,0 kg
Weight PVDF	7,0 Kg
Weight AISI 316	14,0 kg

* The curves and performance values refer to pumps with submerged suction and a free delivery outlet with water at 20°C, and vary according to the construction material.

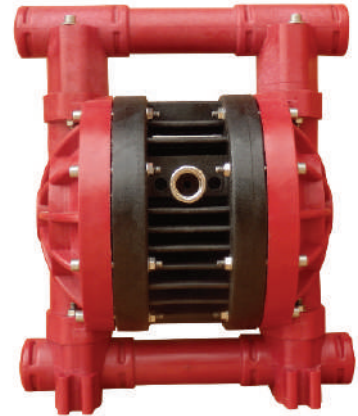

RUBY 025 - FULL CAPACITY PTFE - A FITTED

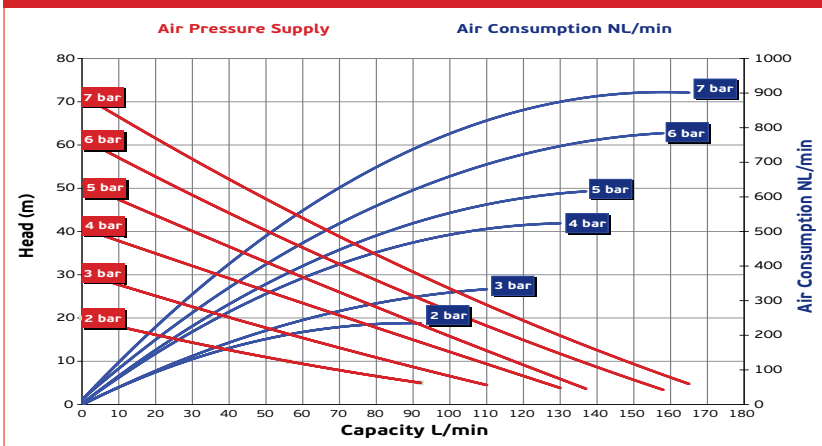

RUBY 025 - RUBBER FITTED

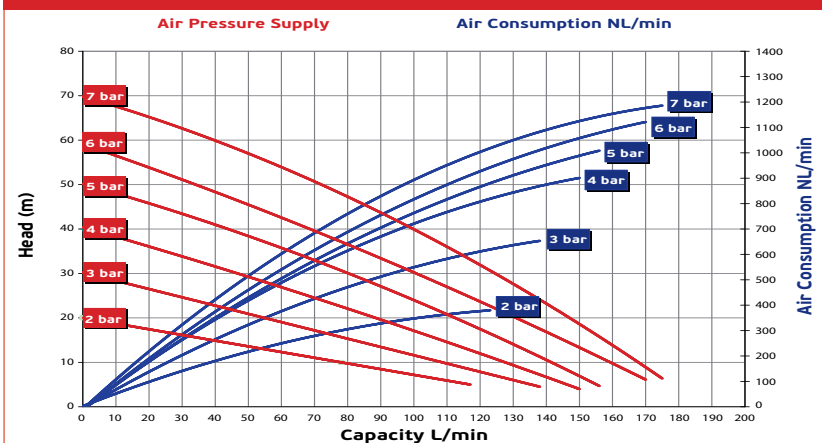

Ruby 125

Construction materials: **ALUMINIUM**



Technical data

ATEX certification	⊕ II 2 G h IIB T4 Gb and II 2 D h IIIB 135°C Db
Construction materials	ALUMINIUM
Diaphragms	NBR Conductive EPDM Conductive Compound PTFE+Back up EPDM Conductive Compound PTFE A + Back up EPDM Conductive VITON Conductive
Intake/delivery connections	1" BSP G -Flange on Request
Air connection	1/2"
*Max. self-priming capacity	5m
*Max. flow rate	185 L/min
Max. head	80 m
Max. air supply pressure	8 bar
Diameter	3,5 mm
Max. operating temp.	95°C - 130°C with Metallic center block
Weight Aluminium	8 kg

* The curves and performance values refer to pumps with submerged suction and a free delivery outlet with water at 20°C, and vary according to the construction material.

RUBY 125 - FULL CAPACITY PTFE - A FITTED

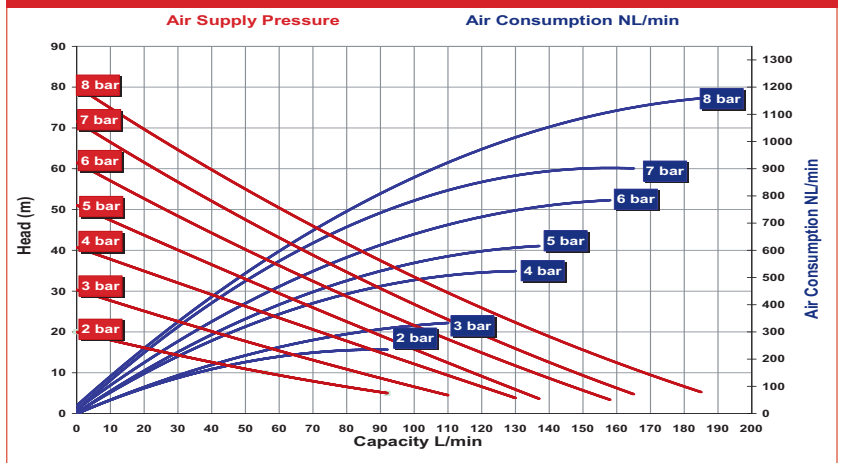

RUBY 125 - RUBBER FITTED

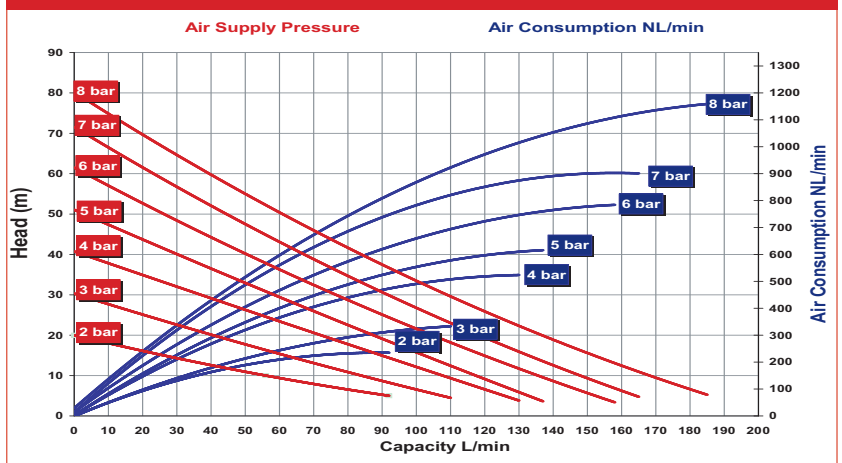

Ruby 040 Pump

Construction materials: PP – PP+CF – PVDF+CF – AISI 316

Technical data

Atex Certification	⊕ II 2 G h IIB T4 Gb and II 2 D h IIB 135°C Db
Construction materials	PP, PP+CF, PVDF+CF, AISI 316
Diaphragms	NBR Conductive EPDM Conductive Compound PTFE+Back up EPDM Conductive Compound PTFE A + Back up EPDM Conductive VITON Conductive
Intake/delivery connections	1 1/2 " BSP G -Flange on Request
Air connection	1/2 "
* Max self-priming capacity	5 m
* Max. flow rate	360 L/min
Max. solid size (diameter)	5mm
Max head	70 m
Max air supply	7 Bar
Max operating Temperature	PP: 60°C, PVDF: 95°C, AISI316: 95°C 130°C with Metallic center block
Weight PP	14 kg
Weight PVDF	22 kg



* The curves and performance values refer to pumps with submerged suction and a free delivery outlet with water at 20°C, and vary according to the construction material.

RUBY 040 - FULL CAPACITY PTFE - A FITTED

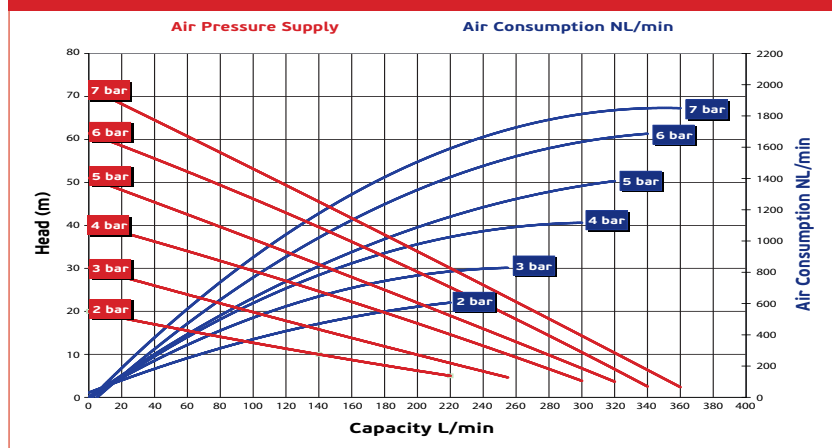

RUBY 040 - RUBBER FITTED

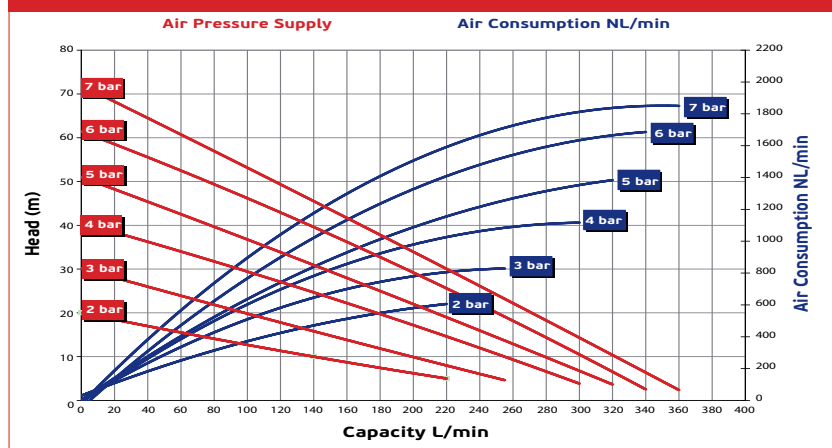

Ruby 140 Pump

Construction materials: **ALUMINIUM**

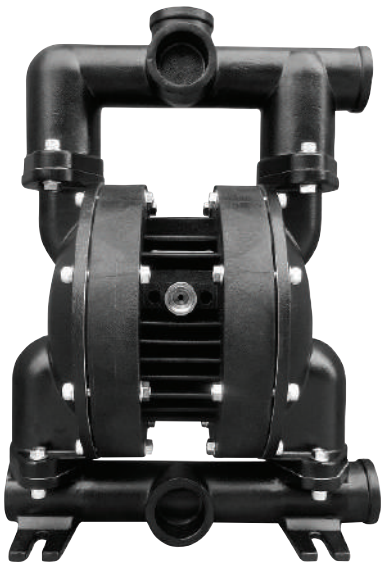

Technical data

Atex Certification	Ⓔ II 2 G h IIB T4 Gb and II 2 D h IIB 135°C Db
Construction materials	ALUMINIUM
Diaphragms	NBR Conductive EPDM Conductive Compound PTFE+Back up EPDM Conductive Compound PTFE A + Back up EPDM Conductive VITON Conductive
Intake / delivery connections	1 1/2" BSP G - Flange on Request
Air connection	1/2 "
* Max self-priming capacity	5 m
* Max. flow rate	375 L/min
Max. solid size (diameter)	5mm
Max head	80 m
Max air supply	8 Bar
Max operating Temperature	95°C 130°C with Metallic center block
Weight	14 kg

* The curves and performance values refer to pumps with submerged suction and a free delivery outlet with water at 20°C, and vary according to the construction material.

RUBY 140 - FULL CAPACITY PTFE - A FITTED

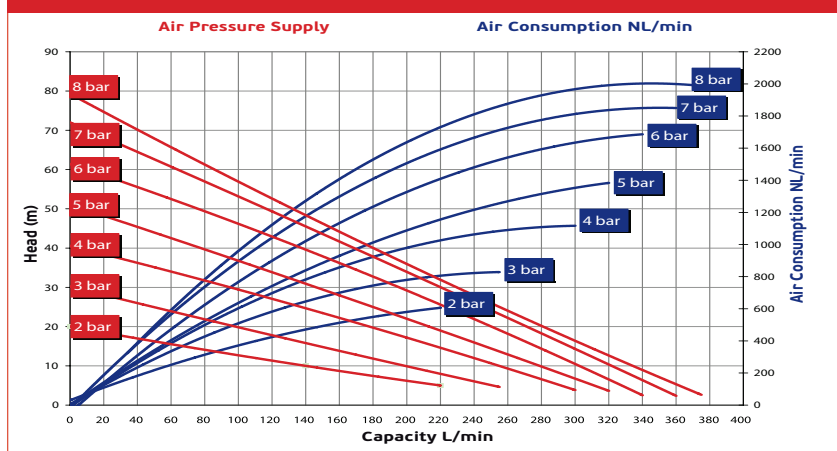

RUBY 140 - RUBBER FITTED

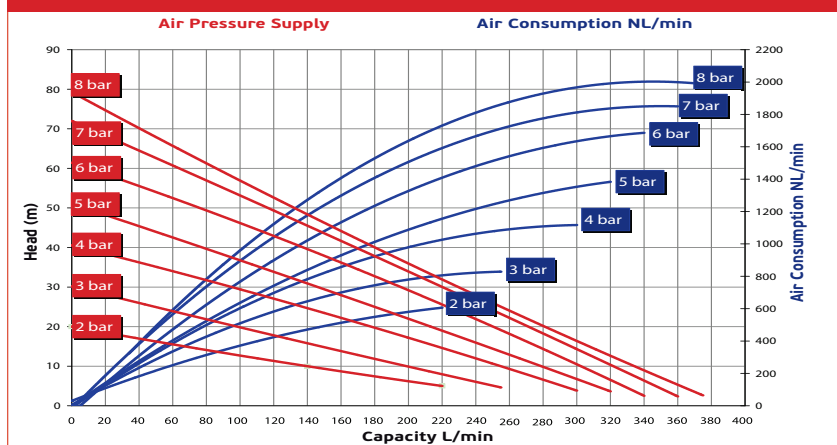

Ruby 050 Pump

Construction materials: **AISI 316**

Technical data

ATEX certification	⊕ II 2 G h IIB T4 Gb and II 2 D h IIB 135°C Db
Construction materials	AISI 316
Diaphragms	NBR Conductive
	EPDM Conductive
	Compound PTFE+Back up EPDM Conductive
	Compound PTFE A + Back up EPDM Conductive
	VITON Conductive
Intake/delivery connections	2" BSP G - Flange on Request
Air connection	3/4"
*Max. self-priming capacity	5 m
*Max. flow rate	696 L/min
Max. head	70 m
Max. air supply pressure	7 bar
Diameter	8 mm
Max. operating temp.	95°C
Weight AISI 316	70 Kg

* The curves and performance values refer to pumps with submerged suction and a free delivery outlet with water at 20°C, and vary according to the construction material.



RUBY 050 - FULL CAPACITY PTFE FITTED

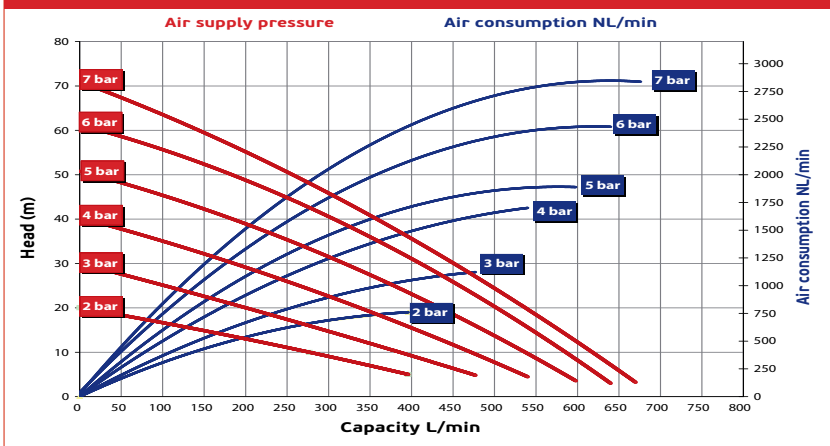

RUBY 050 - RUBBER FITTED

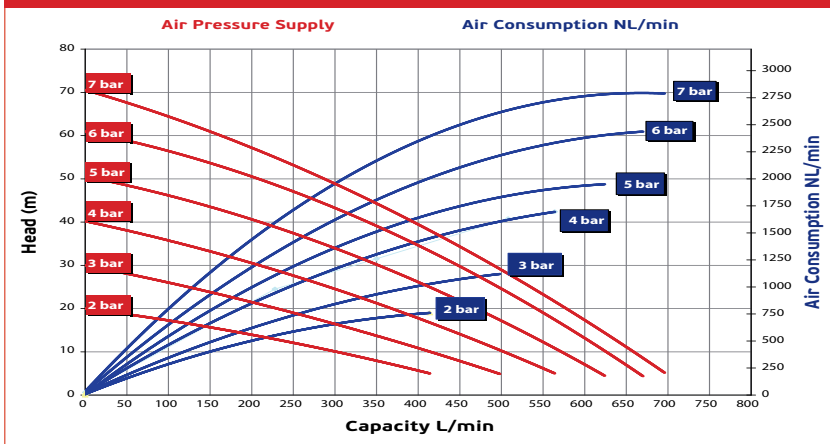

Ruby 150 Pump

Construction materials: **ALUMINIUM**



Technical data

ATEX certification	Ex II 2 G h IIB T4 Gb and II 2 D h IIB 135°C Db
Construction materials	ALUMINIUM
Diaphragms	NBR Conductive EPDM Conductive Compound PTFE+Back up EPDM Conductive Compound PTFE A + Back up EPDM Conductive VITON Conductive
Intake/delivery connections	2" BSP G - Flange on Request
Air connection	3/4"
*Max. self-priming capacity	5 m
*Max. flow rate	696 L/min
Max. head	80 m
Max. air supply pressure	8 bar
Diameter	8 mm
Max. operating temp.	95°C
Weight Aluminium	35 kg

* The curves and performance values refer to pumps with submerged suction and a free delivery outlet with water at 20°C, and vary according to the construction material.



RUBY 150 - FULL CAPACITY PTFE FITTED

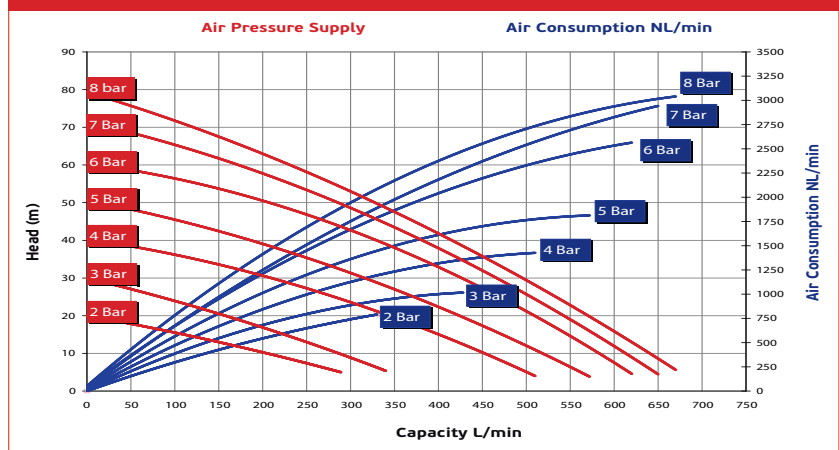

RUBY 150 - RUBBER FITTED

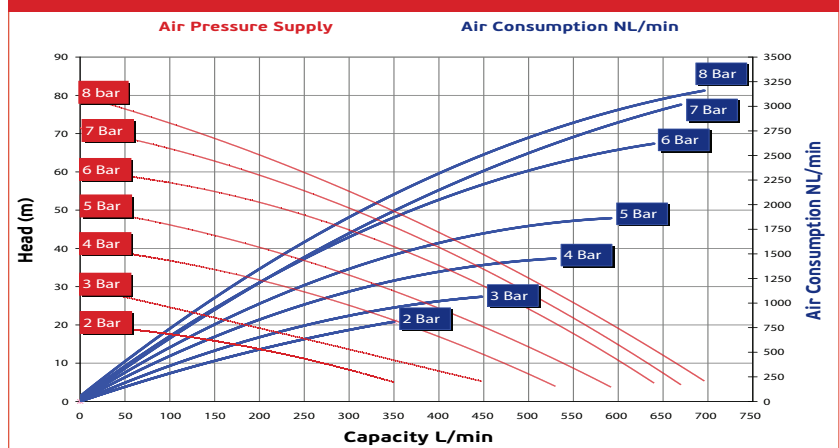

Ruby 051 Pump

Construction materials: PP – PP+CF – PVDF+CF

Technical data

ATEX certification	Ⓔx II 2 G h IIB T4 Gb and II 2 D h IIB 135°C Db
Construction materials	PP, PP+CF, PVDF+CF
Diaphragms	PTFE+back up (santoprene) PTFE+back up (Hytrel) NBR, EPDM, SANTOPRENE, HYTREL
Intake/delivery connections	1/2" BSP G - Flange on Request
Air connection	3/4"
Max. self-priming capacity	5 m
Max. flow rate	650 L/min
Max. head	70 m
Max. air supply pressure	7 bar
Max solid size (diameter)	8 mm
Max. operating temp.	PP 60°C, PVDF 95°C, P, P+CF 60°C
Weight PP	38 Kg
Weight PVDF	45 Kg



* The curves and performance values refer to pumps with submerged suction and a free delivery outlet with water at 20°C, and vary according to the construction material.

RUBY 051 - FULL CAPACITY PTFE FITTED

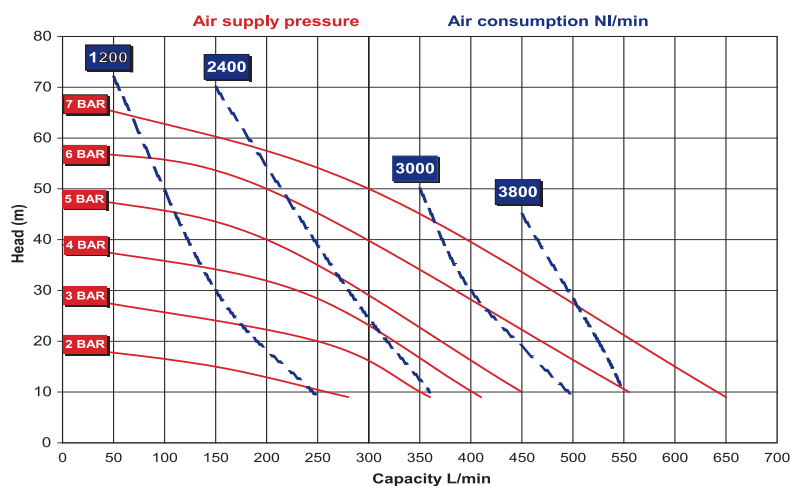

Ruby 080 Pump

Construction materials: **AISI 316**

Technical data

ATEX certification	⊕ II 2 G h IIB T4 Gb and II 2 D h IIIB 135°C Db
Construction materials	AISI 316
Diaphragms	NBR Conductive EPDM Conductive Compound PTFE+Back up EPDM Conductive Compound PTFE A + Back up EPDM Conductive VITON Conductive
Intake/delivery connections	3" BSP G - Flange on Request
Air connection	3/4"
*Max. self-priming capacity	5 m
*Max. flow rate	810 L/min
Max. head	70 m
Max. air supply pressure	7 bar
Diameter	8 mm
Max. operating temp.	95°C
Weight AISI 316	75 Kg

* The curves and performance values refer to pumps with submerged suction and a free delivery outlet with water at 20°C, and vary according to the construction material.



RUBY 080 - FULL CAPACITY PTFE FITTED

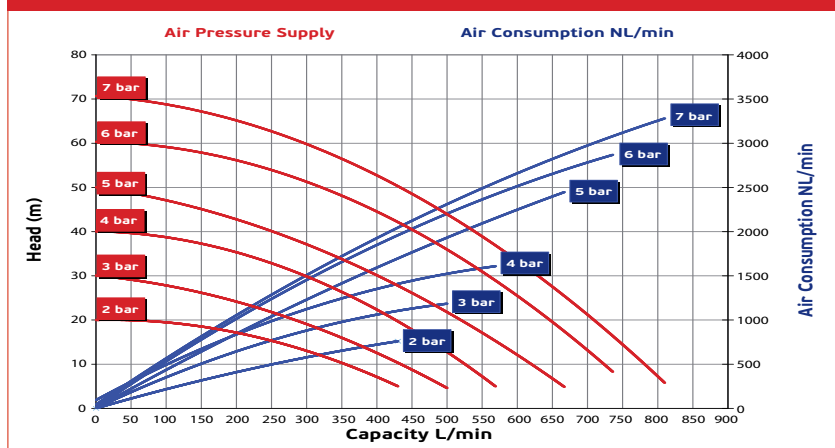

RUBY 080 - RUBBER FITTED

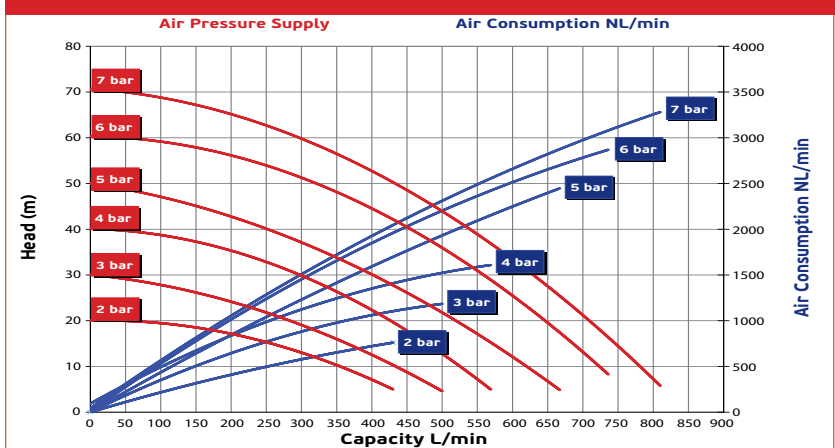

Ruby 180

Construction materials: **ALUMINIUM**

Technical data

ATEX certification	Ex II 2 G h IIB T4 Gb and II 2 D h IIB 135°C Db
Construction Materials	ALUMINIUM
Diaphragms	NBR Conductive
	EPDM Conductive
	Compound PTFE+Back up EPDM Conductive
	Compound PTFE A + Back up EPDM Conductive
VITON Conductive	
Intake / Delivery connections	3" BSP G - Flange on request
Air Connection	3/4 "
*Max.self-priming capacity	5 m
*Max. Flow rate	850 L/min
Max. Head	80 m
Max.Air supply pressure	8 Bar
Max.Solids	8 mm
Max. Temperature	95°C
Weight	50 Kg

* The curves and performance values refer to pumps with submerged suction and a free delivery outlet with water at 20°C, and vary according to the construction material.



RUBY 180 - FULL CAPACITY PTFE FITTED

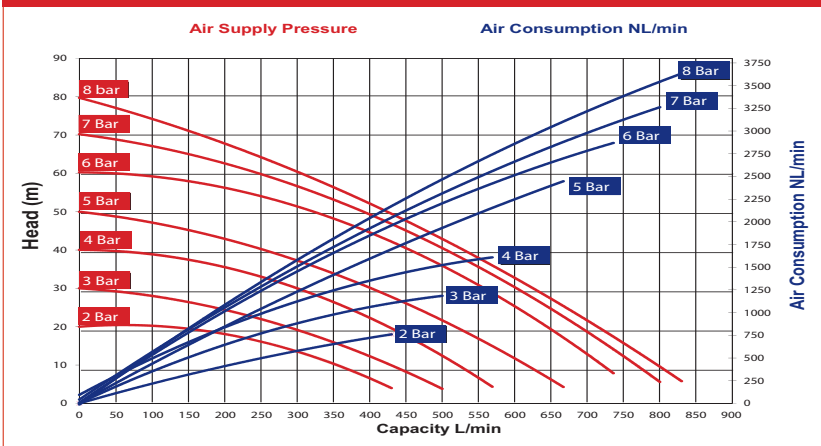

RUBY 180 - RUBBER FITTED

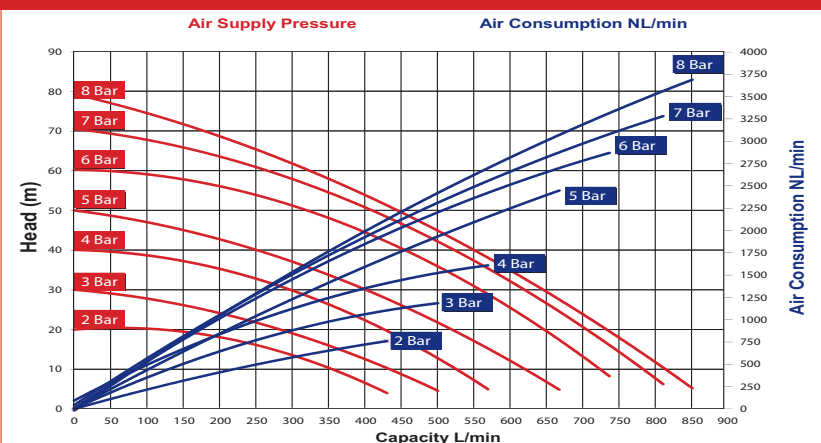

Ruby 081 Pump

Construction materials: PP – PVDF – PP+CF

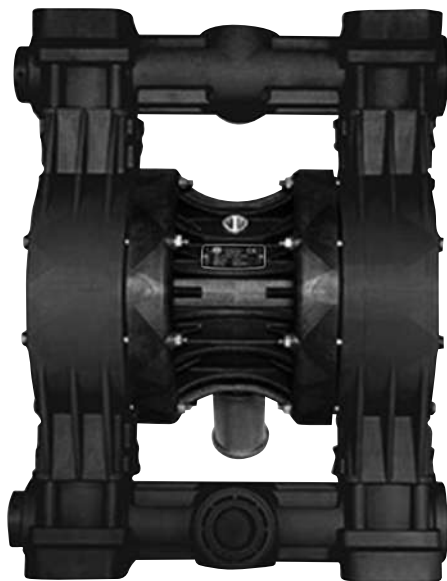
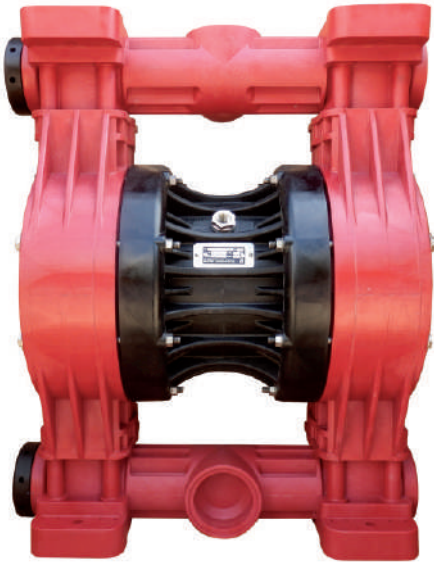

Technical data

ATEX certification	Ⓔ II 2 G h IIB T4 Gb and II 2 D h IIB 135°C Db
Construction materials	PP, PVDF, PP+CF
Diaphragms	PTFE+back up (santoprene) PTFE+back up (Hytrel) NBR, EPDM, SANTOPRENE, HYTREL
Intake/delivery connections	3" BSP G – Flange on request
Air connection	3/4"
Max. self-priming capacity	5 m
Max. flow rate	900 L/min
Max. head	70 m
Max. air supply pressure	7 bar
Max solid size (diameter)	10 mm
Max. operating temp.	PP 60°C, PVDF 95°C, PP+CF 60°C
Weight PP	50 Kg
Weight PVDF	67 Kg

* The curves and performance values refer to pumps with submerged suction and a free delivery outlet with water at 20°C, and vary according to the construction material.

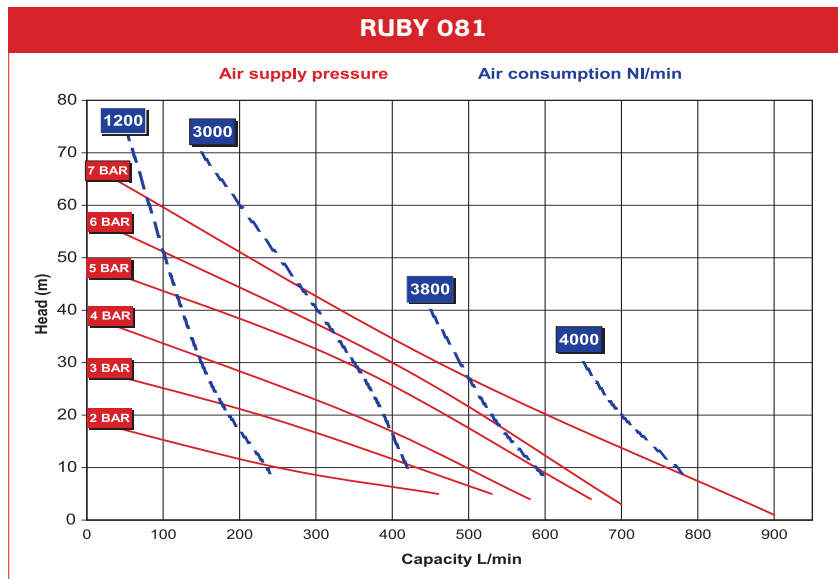

Certifications

Quality Standards

AlphaDynamic PUMPS designs, develops and manufactures pumps and parts with the highest quality standards.

AlphaDynamic PUMPS consistently exceeds the expectations for service, quality and integrity, through it's deep commitment to manufacture in compliance with all industrial certifications, including ISO Certification, CE Certification and Explosion Proof ATEX II 2G h IIB T4 Gb and II 2D h IIB 135°C Db Certification.

AlphaDynamic PUMPS invests in employees and distributors/partners who are keen and willing to keep up with the company's philosophy for excellence, innovation and high customer service, creating and establishing all together a Great Brand. The Ruby Brand.

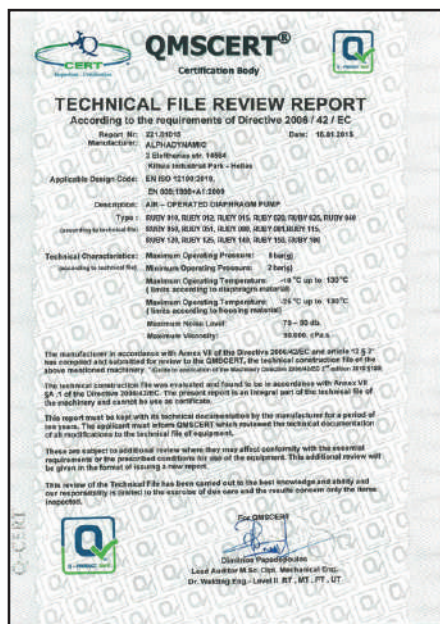
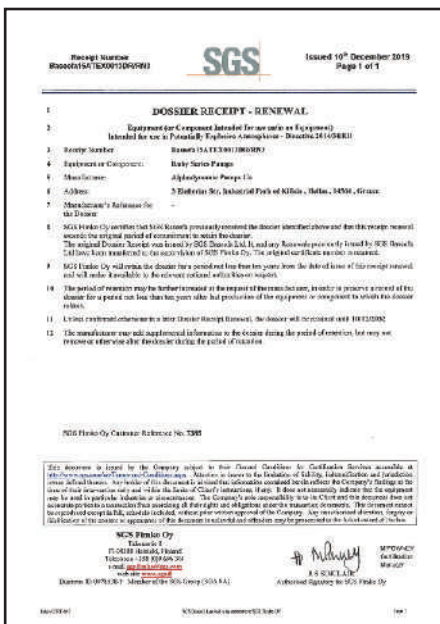



Ver 2020.01.2000



England Sales office:

Rockleigh House, 37 Burton Road
Ashby de la Zouch, Leicestershire
LE65 2LF - United Kingdom (UK)
Registered in ENGLAND & WALES
Registration number 09706219 - VAT No.GB220393343
Tel +44 1213 680 324 , +44 1213 680472
email:sales@alphadynamicpumps.co.uk
www.alphadynamicpumps.co.uk

Hellas Production Facilities:

3 Eleftherias Str Industrial Park of Kifisia
14564 - Kifisia - Hellas
VAT No. EL 999695309
Tel: +30 215 215 9580, +30 215 215 9520
Fax +30 211 268 68 37
email: info@alphadynamic.eu
www.alphadynamic.eu